

# **Video Decoders**

## Quick Guide

Manual Version: V1.00

Thank you for purchasing our product. If there are any questions, or requests, please do not hesitate to contact the dealer.

## Copyright

Copyright 2014-2015 Zhejiang Uniview Technologies Co., Ltd. All rights reserved. No part of this manual may be copied, reproduced, translated, or distributed in any form or by any means without prior consent in writing from our company.

## Trademark Acknowledgement

 and other Uniview's trademarks and logos are the property of Zhejiang Uniview Technologies Co., Ltd. Other trademarks, company names and product names contained in this manual are the property of their respective owners.

## Disclaimer



### CAUTION!

The default password is used for your first login. To ensure account security, please change the password after your first login. You are recommended to set a strong password (no less than eight characters).

---

- To the maximum extent permitted by applicable law, the product described, with its hardware, software, firmware and documents, is provided on an "as is" basis.
- Best effort has been made to verify the integrity and correctness of the contents in this manual, but no statement, information, or recommendation in this manual shall constitute formal guarantee of any kind, expressed or implied. We shall not be held responsible for any technical or typographical errors in this manual. The

contents of this manual are subject to change without prior notice. Update will be added to the new version of this manual.

- Use of this manual and the product and the subsequent result shall be entirely on the user's own responsibility. In no event shall we be reliable to you for any special, consequential, incidental, or indirect damages, including, among others, damages for loss of business profits, business interruption, or loss of data or documentation, or product malfunction or information leakage caused by cyber attack, hacking or virus in connection with the use of this product.
- Video and audio surveillance can be regulated by laws that vary from country to country. Check the law in your local region before using this product for surveillance purposes. We shall not be held responsible for any consequences resulting from illegal operations of the device.
- The illustrations in this manual are for reference only and may vary depending on the version or model. The screenshots in this manual may have been customized to meet specific requirements and user preferences. As a result, some of the examples and functions featured may differ from those displayed on your monitor.
- This manual is a guide for multiple product models and so it is not intended for any specific product.
- Due to uncertainties such as physical environment, discrepancy may exist between the actual values and reference values provided in this manual. The ultimate right to interpretation resides in our company.



## **Environmental Protection**

This product has been designed to comply with the requirements on environmental protection. For the proper storage, use and disposal of this product, national laws and regulations must be observed.



# Safety and Compliance Information

## Safety Symbols

The symbols in the following table may be found on installation-related equipment. Be aware of the situations indicated and take necessary safety precautions during equipment installation and maintenance.

Symbol	Description
	Generic alarm symbol: To suggest a general safety concern.
	ESD protection symbol: To suggest electrostatic-sensitive equipment.
	Electric shock symbol: To suggest a danger of high voltage.

The symbols in the following table may be found in this manual. Carefully follow the instructions indicated by the symbols to avoid hazardous situations and use the product properly.

Symbol	Description
 <b>WARNING!</b>	Indicates a hazardous situation which, if not avoided, could result in bodily injury or death.
 <b>CAUTION!</b>	Indicates a situation which, if not avoided, could result in damage, data loss or malfunction to product.
 <b>NOTE!</b>	Indicates useful or supplemental information about the use of product.

## Safety Information

Installation and removal of the unit and its accessories must be carried out by qualified personnel. Please read all of the safety instructions below before installation and operation.

- This device is a class A product and may cause radio interference. Take measures if necessary.
- While shipping, the device should be packed in its original packing.
- Verify that installation is correct. Incorrect cable connection may cause personal injury or device damage.
- The installation must be made by qualified personnel and should conform to all the local codes.
- If the product does not work properly, please contact your dealer. Never attempt to disassemble the device yourself. We shall not assume any responsibility for problems caused by unauthorized repair or maintenance.
- Ensure a proper operating environment, including temperature, humidity, ventilation and power supply. Make sure the device is properly grounded and the lightning protection meets requirements. Keep the device from moisture, dust, strong electromagnetic radiation and vibration.
- Power down the device before connecting and disconnecting accessories and peripherals.
- Protect the power cable from being stepped on or pressed, particularly at the plug, receptacle, and the part leading out of the device.
- Strictly follow the procedure to shut down the device. Sudden power failures can cause disk damage and functional abnormalities. In an environment where power supply is frequently interrupted, use an Uninterrupted Power Supply (UPS).
- Improper use or replacement of the battery may result in hazard of explosion. Use the manufacturer recommended battery.
- Take necessary measures to ensure data security and protect the device from network attack and hacking (when connected to Internet). Possible risks and consequences are at user's sole discretion.



## **WARNING!**



- Never look at the transmit laser while the power is on. Never look directly at the fiber ports and the fiber cable ends when they are powered on.
  - Use of controls or adjustments to the performance or procedures other than those specified herein may result in hazardous laser emissions.
- 

## **Regulatory Compliance**

### **FCC Part 15**

This equipment has been tested and found to comply with the limits for digital device, pursuant to part 15 of the FCC Rules. These limits are designed to provide reasonable protection against harmful interference when the equipment is operated in a commercial environment. This equipment generates, uses, and can radiate radio frequency energy and, if not installed and used in accordance with the instruction manual, may cause harmful interference to radio communications. Operation of this equipment in a residential area is likely to cause harmful interference in which case the user will be required to correct the interference at his own expense.

This product complies with Part 15 of the FCC Rules. Operation is subject to the following two conditions:

1. This device may not cause harmful interference.
2. This device must accept any interference received, including interference that may cause undesired operation.

## **LVD/EMC Directive**



This product complies with the European Low Voltage Directive 2006/95/EC and EMC Directive 2004/108/EC.

## **WEEE Directive–2002/96/EC**



The product this manual refers to is covered by the Waste Electrical & Electronic Equipment (WEEE) Directive and must be disposed of in a responsible manner.

# Contents

---

<b>1 Overview.....</b>	<b>1</b>
Appearance.....	1
LEDs.....	2
Main Ports.....	3
<b>2 Installing the Device .....</b>	<b>5</b>
Preparation .....	5
Checking the Device Package .....	5
Checking the Installation Environment.....	5
Cable Requirements .....	6
Installation Flow Chart .....	8
Installing the Device in a Rack.....	10
Preparing for the Installation.....	10
Installing the Mounting Brackets.....	10
Installing the Device in the Rack.....	11
Verifying the Installation .....	12
Installing the Device on a Workbench .....	13
Preparation for the Installation .....	13
Installation Procedure .....	13
Connecting Cables.....	13
Cabling Requirements .....	13
Example for Connecting Cables .....	14
Connecting the Ground Wire.....	15
Connecting the Audio Cables and Alarm Cables.....	17
Connecting video cables .....	19
Connecting Network Cables .....	19
Connecting the AC Power Cord .....	19



Connecting RS-232 Serial Cables .....	21
Connecting a Third-Party Device .....	21
Verifying the Installation.....	21
Starting Up the Device .....	21
<b>3 Logging In to and Out of the Device .....</b>	<b>22</b>
<b>4 Technical Specifications .....</b>	<b>22</b>

# 1 Overview

---



## NOTE!

This manual describes the device hardware information and installation procedure, and guides you through logging into the Web interface.

---

This series video decoders (referred to as device in this manual) are new generation HD network video decoder terminals. The device is designed for remote video surveillance and can be widely applied in various real-time surveillance applications for monitoring audios and videos remotely in real time.

For information about the technical specifications of the device, see [Technical Specifications](#).

## Appearance

**Figure 1-1** Front view

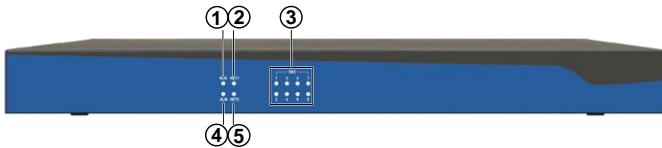

1: RUN LED	2: NET1 LED	3: DEC LED	4: Alarm LED	5: NET2 LED
------------	-------------	------------	--------------	-------------

**Figure 1-2** Rear view

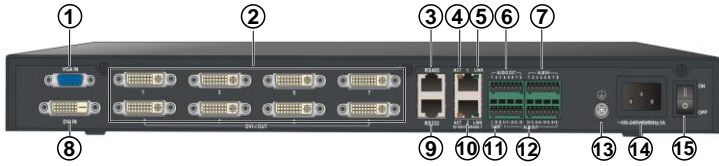

1: VGA IN port	2: DVI-I OUT port	3: RS-485 port (RJ-45)
4: ACT LED	5: LINK LED	6: AUDIO OUT port
7: ALM IN port	8: DVI IN port	9: RS-232 port (RJ-45)
10: Two Ethernet copper ports	11: LINE port	12: ALM OUT port
13: Grounding screw	14: AC power input	15: Power switch

## LEDs

**Table 1-1** LED description

LED	Status	Description
Running LED	Flashing green	The device is starting up.
	On (Green)	The device is operating.
	Off	The device is shut down.
Alarm LED	On (Red)	At least one alarm, for example, temperature alarm, is present.
	Off	No alarm is present.
LINK LED for Ethernet copper port 1 (NET1)	On (Green)	A link to the Ethernet copper port 1 is present.
	Off	No link to the Ethernet copper port 1 is present.
LINK LED for Ethernet copper port 2 (NET2)	On (Green)	A link to the Ethernet copper port 2 is present.
	Off	No link to the Ethernet copper port 2 is present.

LED	Status	Description
Decoding LED (DEC)	Flashing green	The device is displaying video.
	Off	The device stops displaying video.
Active LED (ACT)	Flashing yellow	Data is being transmitted or received.
	Off	No data is being transmitted or received.
Link LED	On (Green)	A link is present.
	Off	No link is present.

## Main Ports

**Table 1-2** Port description

Port	Quantity	Description
VGA IN	1	VGA video input port, used for receiving analog video signals from the VGA output port of a video source. <b>Note:</b> Make sure the connected video source supports the following resolutions: 1024*768/60HZ,                      1280*720/60HZ, 1280*1024/60HZ,                    1920*1080/60HZ, 1920*1080/50HZ.
DVI IN	1	DVI-D video input port, used for receiving digital video signals from DVI-D output port and HDMI output port of the video source. <b>Note:</b> Make sure the connected video source supports the following resolutions: 1024*768/60HZ,                      1280*720/60HZ, 1280*1024/60HZ,                    1920*1080/60HZ, 1920*1080/50HZ.

Port	Quantity	Description
DVI-I OUT	4 or 8, depending on model	DVI-I video output port, used for outputting video signals to a display output device with HDMI port, DVI-D port, VGA port (5-wire), or YPbPr port. <b>Note:</b> Make sure the connected display output device supports the following resolutions: 1024*768/60HZ, 1280*720/60HZ, 1280*1024/60HZ, 1360*768/60HZ, 1600*1200/60HZ, 1920*1080/60HZ, 1920*1080/50HZ.
AUDIO OUT	4 or 8, depending on model	Used to output audio signals. Phoenix connector. For more information, see <a href="#">Table 2-3</a> . Electrical level: 2.0V to 2.4V (P-P); Impedance: 5 Kohm
LINE	1 input 1 output	Used to input and output audio signals. Phoenix connector. For more information, see <a href="#">Table 2-3</a> . LINE I: 2V (P-P), 10 Kohm; LINE O: 2V (P-P), 600 ohm
ALM IN	8	Used to input Boolean alarm signals. Phoenix connector. For more information, see <a href="#">Table 2-3</a> .
ALM OUT	6	Used to output alarm signals through relay. Phoenix connector. For more information, see <a href="#">Table 2-3</a> .
RS485	1	Serial port, used to interoperate with the connected device, for example, to transmit transparent channel data. RJ-45 connector, four wires, supporting full duplex and half duplex.
RS232	1	Serial port, used to debug and maintain the device. RJ-45 connector.

Port	Quantity	Description
Ethernet copper port	2	Used to connect to Ethernet to communicate with the devices on the network, to receive IP camera streams, and to be configured by the client through Web interface. 10M/100M/1000M/auto-sensing, half duplex/full duplex/auto-sensing, RJ-45 connector.

## 2 Installing the Device

---

### Preparation

#### Checking the Device Package

Before you install the device, verify the device model and check the components and their quantity against the packing list to make sure all items listed are included in the package.



#### **WARNING!**

Do not remove the dismantlement-preventive seal from the device chassis cover without permission. To open the chassis, contact your dealer. Otherwise, we shall not be held liable for any consequence caused thereby.

---

#### Checking the Installation Environment

The device can be installed indoors only, and must meet the following requirements:

- Use correct lightning protection devices for the device power source, audio/video signals, and RS-485 ports.

- Ground the device correctly through the grounding screw. For more information, see the *Encoder and Decoder Cable Connection Guide*.

## Cable Requirements

---



### **NOTE!**

For information about how to select the common cables, contact your dealer.

---

### **VGA cables**

- Use UL-certified VGA cables with shielding rings and gold-plated connectors.
- Use cables with pure copper or oxygen-free copper shielded with tinplated layer. The wire gage of the core conductor should be in the range of 24 AWG to 28 AWG. A smaller gage means a thicker wire diameter and a better transmission effect.
- The transmission distance of an ordinary cable is 15 meters (49.21 ft), and that of a better project-level cable can be 50 meters (164.04 ft).

### **HDMI cables**

- Use HDMI Association-certified HDMI cables with shielding rings and gold-plated connectors.
- Use cables with pure copper with 96 copper braiding or more. The wire gage of the core conductor should be in the range of 24 AWG to 28 AWG.
- If you use an HDMI cable longer than 10 meters (32.81 ft) to transmit 1080P signals, you are recommended to use 24 AWG. If you want to transmit signals for 20 meters (65.62 ft) or longer, you

are recommended to use an HDMI signal amplifier or HDMI extension cord.

### **DVI cables**

A DVI connector can transmit multiple types of video signals, and different cables are used for different signals. If the DVI connector is not connected to an adapter, the requirements for DVI cables are similar with those for HDMI cables.

### **Audio cables**

Use 4-wire shielded cables (RVVP) or unshielded digital communication cables (UTP). The sectional area of the cable conductor should be large, for example, 0.5 mm<sup>2</sup>. You are recommended to use dedicated shielded audio cables, and the cable length is 100 meters (328.08 ft). Commonly used audio cables include RCA audio cables and ordinary coaxial cables.

### **Alarm cables**

Twisted pair cables are recommended. The wire gage of the insulated core conductor should be in the range of 22 AWG to 28 AWG (24 and 26 AWG are recommended). The maximum DC impedance must not be more than 100 ohm.

The following table shows the maximum length of alarm cables for wire gages, taking 100 ohm as the benchmark.

**Table 2-1** Maximum alarm cable length for different wire gages

<b>Wire gage (AWG)</b>	<b>Maximum cable length</b>
22	1453 m (4767.06 ft)
24	914 m (2998.69 ft)
26	570 m (1870.08 ft)
28	360 (1181.10 ft)



### **Network cables**

Use twisted-pair cables. Currently, twisted pair cables include unshielded twisted pair (UTP) and shielded twisted pair (STP). STP cables are shielded with aluminum foil for radiation reduction purpose. STP cables are more expensive than UTP cables, and they are harder to install.

### **Ground wire**

The length of the ground wire should be no more than 30 meters (98.43 ft), and its impedance must be less than 5 ohm. For more information, see Standard YD5098.

## **Installation Flow Chart**

Make sure the device is disconnected from the power source when you install the device.

**Figure 2-1** Installation flow chart

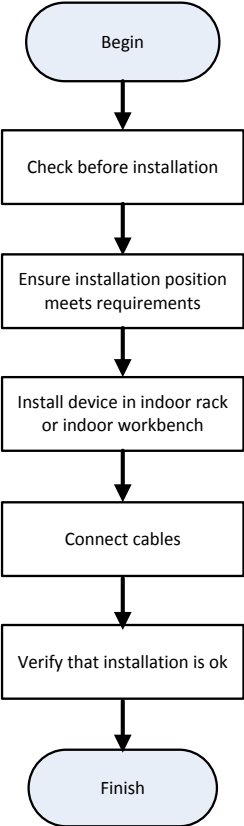

## Installing the Device in a Rack

---



### **NOTE!**

- You can install your device in a standard 19-inch rack. The rack should meet the requirement on bearing the weight of the device and its accessories. The following section uses a standard 19-inch rack as an example.
  - Before the installation, make sure the rack is stable and correctly grounded, and make sure there are no obstacles that might hamper the installation inside or near the rack.
- 

You can front-mount or rear-mount your device in a standard 19-inch rack with mounting brackets.

Installing the device to a rack does not require sliding rails or a tray. The mounting brackets can bear the weight of the device.

The following describes how to front-mount the device. The rear-mounting method is similar, and thus not provided in this manual.

### Preparing for the Installation

- Examine the grounding and stability of the rack, determine the device installation position in the rack, and make sure there are no obstacles that might hamper the installation inside or near the rack.
- Move your device to a place near the rack.

### Installing the Mounting Brackets

#### **Checking before the installation**

Mounting brackets are placed in the accessory package with screws. Each device is shipped with two identical mounting brackets.

## Installation procedure

1. As shown in [Figure 2-2](#), put the screw-hole side of the bracket against the chassis tightly, align the screw holes on the bracket with those on the chassis, and then fix the bracket to the chassis tightly with two M4\*8 screws.
2. Use the same method to install the other mounting bracket.

**Figure 2-2** Installing the mounting brackets

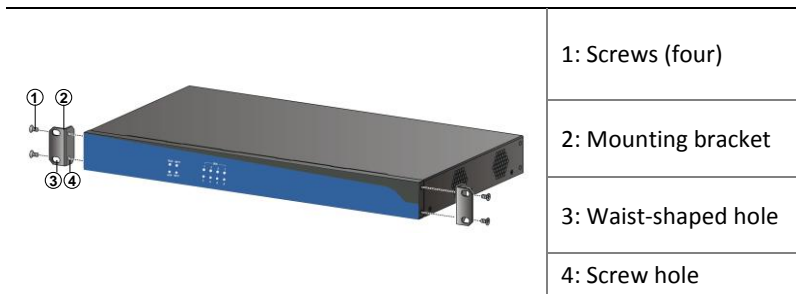

## Installing the Device in the Rack

Place your device horizontally to a proper position in the rack, and align the mounting brackets along the front posts of the rack. Put the screws through the waist-shaped holes to contact the floating nuts on the front posts, and fix the mounting brackets to the front posts of the rack, as shown in [Figure 2-3](#).

**Figure 2-3** Installing the device in the rack

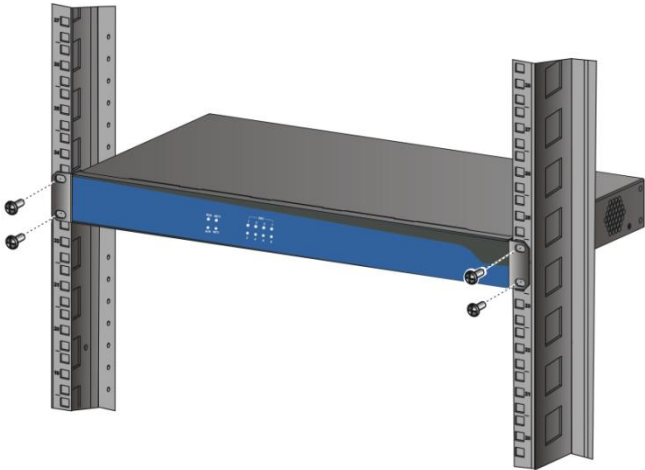

### Verifying the Installation

After you install the device in the rack, examine the installation against the following checklist. Make sure all check results are positive.

**Table 2-2** Installation checklist

No.	Item Description	Result		Remarks
		Yes	No	
1	The mounting brackets are fixed tightly to the device.			
2	The device is installed at a correct position.			
3	The mounting brackets are fixed tightly to the posts on the rack.			

## Installing the Device on a Workbench

If you do not have a standard 19-inch rack, you can install your device on a workbench.

### Preparation for the Installation

- Make sure the workbench is sturdy enough to bear the weight of your device, its accessories, and cables.
- Make sure the workbench is stable and correctly grounded.
- Your device is shipped with foot mats. Remove the stickers from the feet mats, and stick the foot mats to the correct positions on the bottom of your device.

### Installation Procedure

1. Lift the device and move it near to the workbench.
  2. Lift the device and place it on the workbench.
- 



#### **CAUTION!**

- To ensure proper heat dissipation, keep at least a clearance of 10 cm (3.94 in.) around the device.
  - Do not place any heavy objects on the device.
- 

## Connecting Cables

### Cabling Requirements

Separate service cables, such as network cables and audio/video cables, from power cords. You can bundle long cables with cable ties and stick labels on them for easy identification.

If your device is installed in a standard 19-inch rack, you can arrange the power cords either over or under the rack to separate from signal cables.

Generally, signal cables are wired through the cabling rack on the top of the rack or through the cabling trough under the ground.

---



**CAUTION!**

- To avoid bodily injury and device damage, make sure the device is powered off before you connect the cables.
  - For related standards for the external cables of the device, see [Cable Requirements](#).
  - Do not bundle cables near the air outlet of the device to avoid speedy aging. Fasten the cables near the device and keep the cables loose between the ports and the fastening points.
- 

## Example for Connecting Cables

---



**NOTE!**

The following is an example. The cable connection for different devices is similar. The actual ports and corresponding devices are subject to the user site.

---

Connect an external device to your device as required. For more information, see related documents for the external device.

**Figure 2-4** Cable connection diagram

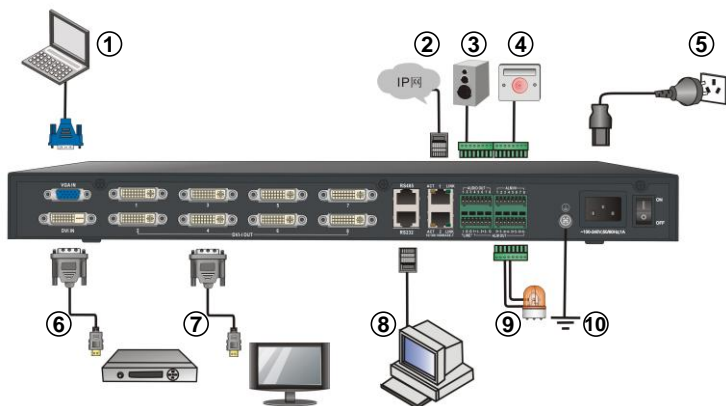

1: VGA port video source, such as PC.	2: Connect your device to the network through a network cable.
3: Audio output device, such as speaker	4: Alarm input device.
5: Power source.	6: Connect your device to a video source (such as DVD) through the DVI-D-to-HDMI cable, taking HDMI port as an example.
7: Connect your device to a display output device through the DVI-I-to-HDMI cable, taking HDMI port as an example.	8: Connect your device to a serial port device (such as a PC) through the serial port cable.
9: Alarm output device.	10: Grounding

## Connecting the Ground Wire



### **WARNING!**

To ensure human and device safety against lightning and interference, the device must be grounded correctly.



As shown in [Figure 2-5](#), connect one end of the ground wire to the grounding screw on the device, and connect the other end to a reliable grounding point.

**Figure 2-5** Connecting the ground wire

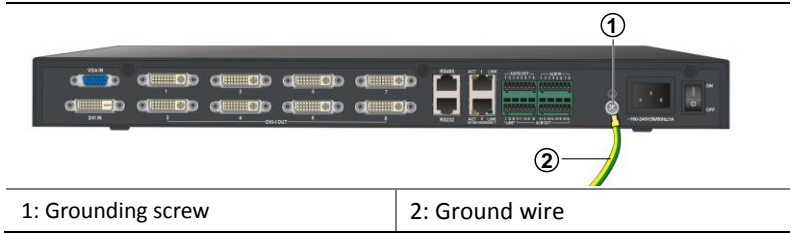

**NOTE!**

Generally, a rack has a grounding bar, where you can connect the ground wire. In actual installation, you can connect the ground wire correctly according to the site conditions. For more information, see the *Encoder and Decoder Cable Connection Guide*.

## Connecting the Audio Cables and Alarm Cables

**Figure 2-6** Connecting the audio cables and alarm cables

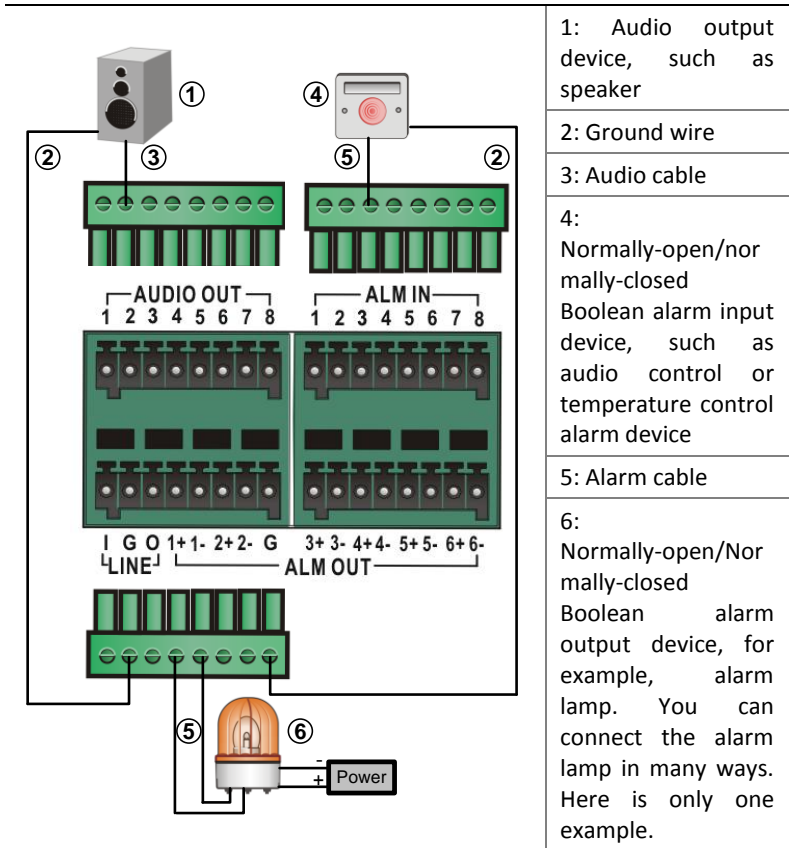

**Table 2-3** Phoenix connector

Pin	Description
AUDIO OUT: <ul style="list-style-type: none"> <li>• 1, 2, 3, 4</li> <li>• 1, 2, 3, 4, 5, 6, 7, 8</li> </ul>	Audio signal output.
LINE: I, O	Audio input and output.

Pin	Description
ALM IN: 1, 2, 3, 4, 5, 6, 7, 8	Alarm signal inputs 1 to 8.
ALM OUT: (1+,1-), (2+,2-), (3+,3-), (4+,4-), (5+,5-), (6+,6-)	Alarm signal outputs 1 to 6.
LINE: G ALM OUT: G	Ground <b>Note:</b> All G pins of the phoenix connector are the same for grounding purpose. You can select any proper G pin for cable connection. Multiple external devices can share a G pin.

Alarm cable connection is illustrated in [Figure 2-6](#). This figure is for reference only.

- The alarm input pins 1 to 8 of the phoenix connector can connect to eight alarm input devices. The figure shows only one connection and the connection method for the other alarm input devices is similar. In actual installation, make sure the connections correspond to the alarm input port configurations on the Web interface.
- The alarm output pin pairs (1+, 1-) to (6+, 6-) of the phoenix connector can connect to six alarm output devices. The plus sign and minus sign mean a pin pair rather than polarity identification. In actual installation, make sure the connections correspond to the Boolean output channel configurations on the Web interface.



### CAUTION!

The operating voltage and current of the power source for the Boolean alarm output device should be no more than 12V DC and 0.7A.

## Connecting video cables

As shown in [Figure 2-4](#), connect one end of a video cable to the video input or output port of the device, and connect the other end to the video device.

For the DVI-D input port and DVI-I output port, you can use a DVI-to-HDMI cable or a DVI-to-VGA cable, or use adapter connector to connect to a proper video device. For more information about adaption ports, see [Table 1-2](#).



### **NOTE!**

Do not over-bend, twist, or heavily press HDMI cables.

---

## Connecting Network Cables

As shown in [Figure 2-4](#), connect one end of the network cable to the Ethernet copper port of the device, and connect the other end to the IP network.

## Connecting the AC Power Cord



### **WARNING!**

Before you connect the power cord, make sure the power switch of your device is turned off to avoid possible bodily injury and device damage.

---

1. Take out the cable-retention clip from the package, and install it to your device, as shown in [Figure 2-7](#).

**Figure 2-7** Installing the cable-retention clip

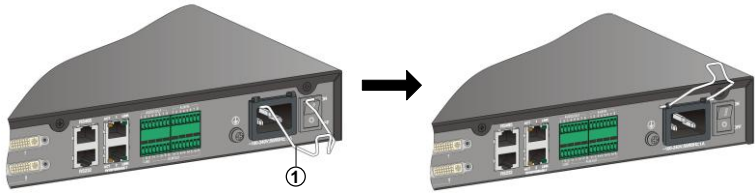

1: Cable-retention clip.

2. Connect the AC power cord and turn the cable-retention clip to hold the power cord tight, as shown in [Figure 2-8](#).

**Figure 2-8** Connecting the AC power cord



**CAUTION!**

When you connect the other end of the power cord to the power source, you are recommended to use a single-phase three-wire power socket with neutral point or multi-function computer power socket. Make sure the neutral point of the power socket is correctly grounded. Generally, the neutral points of the power supply system of the building have been grounded correctly during construction.

## Connecting RS-232 Serial Cables

As shown in [Figure 2-4](#), when you use the RS-232 serial cable to connect your device with a serial port device (for example, a PC) through the RS-232 serial port, see the *Encoder and Decoder Cable Connection Guide*.

## Connecting a Third-Party Device

When you use the serial cable to connect your device with a third-party device through the RS-485 serial port in transparent channel mode, see the *Encoder and Decoder Cable Connection Guide*.

## Verifying the Installation



---

### **WARNING!**

To avoid bodily injury and device damage caused by incorrect cable connection, verify the installation before you connect the device to the power source.

---

To verify the installation, check the following:

- The device is installed stably with all screws fixed tightly.
- No objects are placed on the top of the device chassis.
- The device is grounded, and all cables are connected correctly.
- The power voltage is stable. The selected power source meets the requirements as described in [Technical Specifications](#).

## Starting Up the Device

After the cables are connected, connect the device with the power source, and start up the device. Examine the device status according to [Table 1-1](#).

## 3 Logging In to and Out of the Device

---

You can manage and maintain the device through the Web interface.

Before you log into the device, verify that:

- The device is operating correctly.
- The network connection between the PC and the device is normal.
- The PC is installed with Microsoft Internet Explorer 7.0 or higher.
- The browser on the PC is not configured with the proxy server.

The default IP address of the device is 192.168.0.14, the subnet mask is 255.255.255.0, and the default gateway is 192.168.0.1.

For the first login, use **admin** as both the username and password.

To log into the Web interface:

1. Use the IE browser on your PC to visit the IP address of the device.
2. On the login page, enter your username and password to access the Web interface.

You can select a menu item on the Web interface and select a tab to enter the corresponding configuration page.

For information about the initial configuration and other parameter configurations, see the online help by clicking the **Help** menu.

For the first login, you are recommended to change the default login password by selecting **Maintenance > Password**.

To log out of the device, you can click the **Exit** menu and confirm your operation to return to the login page.

## 4 Technical Specifications

---

For detailed specification of the device, see the product brochure.

**Table 4-1** Technical specifications

Item	Description
Dimensions (W × D × H)	43.6 mm × 440 mm × 320 mm (17.32" × 9.45" in × 1.72")
Weight	4 kg (8.82 lb)
Operation voltage	100 V to 240 V
Max. power consumption	50W to 70W, depending on the device model
Operation temperature	−10°C to +55°C (14°F to 131°F)
Operation humidity	10% to 95% (non-condensing)
Storage temperature	−40°C to +70°C (−40°F to +158°F)
Storage humidity	5% to 95% (non-condensing)
Altitude	−60 m to +5000 m (−196.85 ft to +16404.20 ft)

This device is an A-category product, which might cause radio interference. To eliminate such interference, you need to take proper measures.



BOM: 3101C0CJ